

09/2013

Mod: DK7/2-NP

Production code: ST805BE2



Diamond
catering equipment

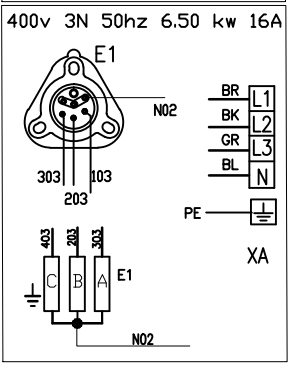
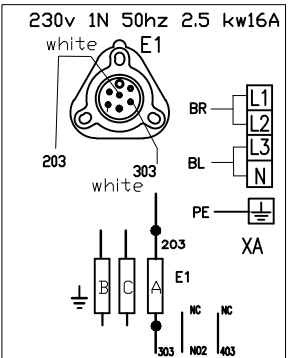
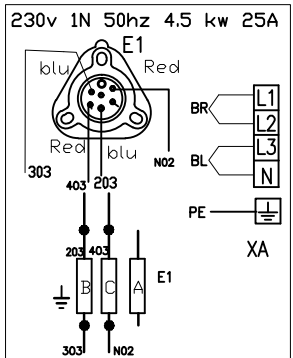
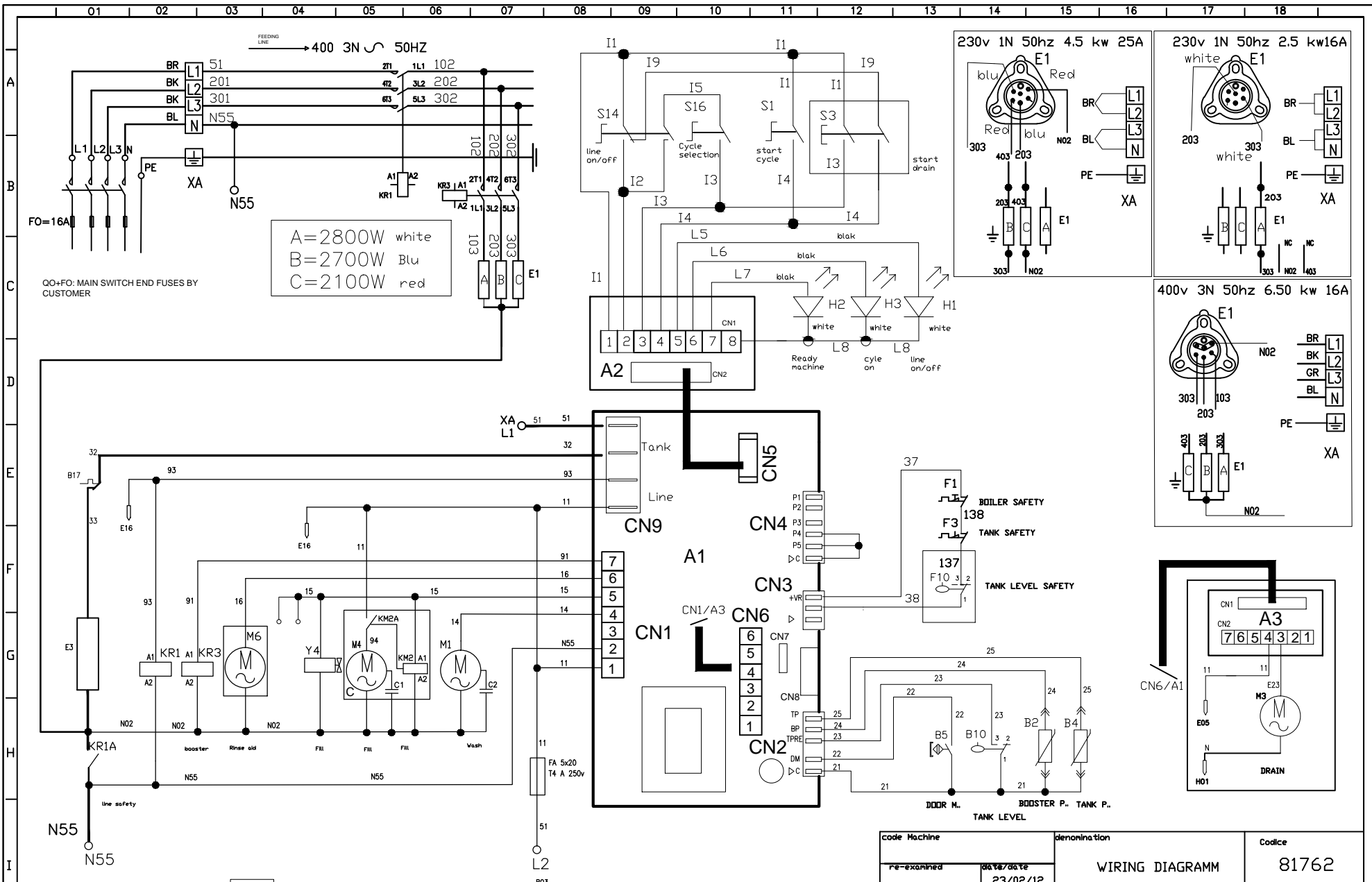

code Machine		denomination		Codice	
re-examined		date/date		81762	
inspected by		date		n°/file	
validated by		date/date		81797	
		Dishwashers		mod	
		total blat		3	
		N° blat		2	
		Next blat		-3	

DESCRIZIONE	Opzionale	A03	SOSTITUISCE	DATA
-3				
-2				

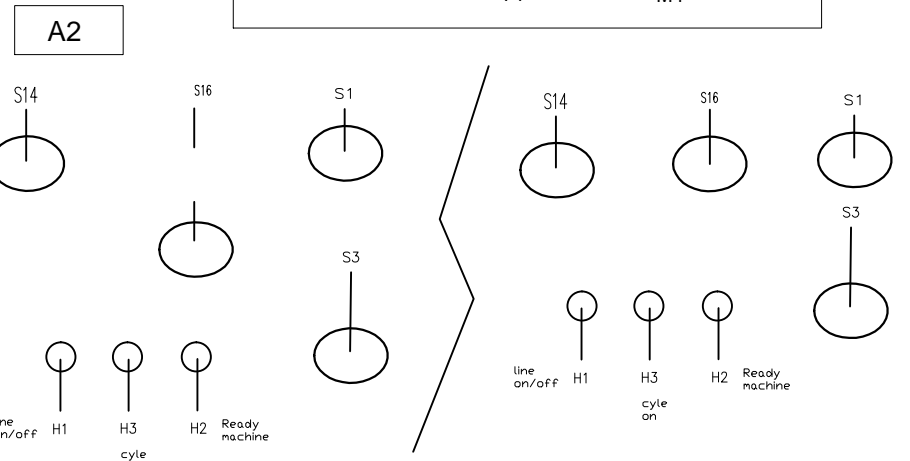
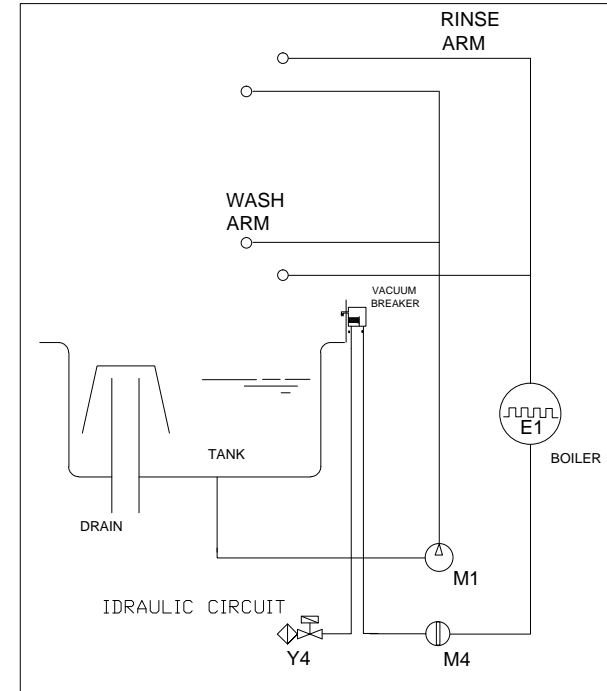
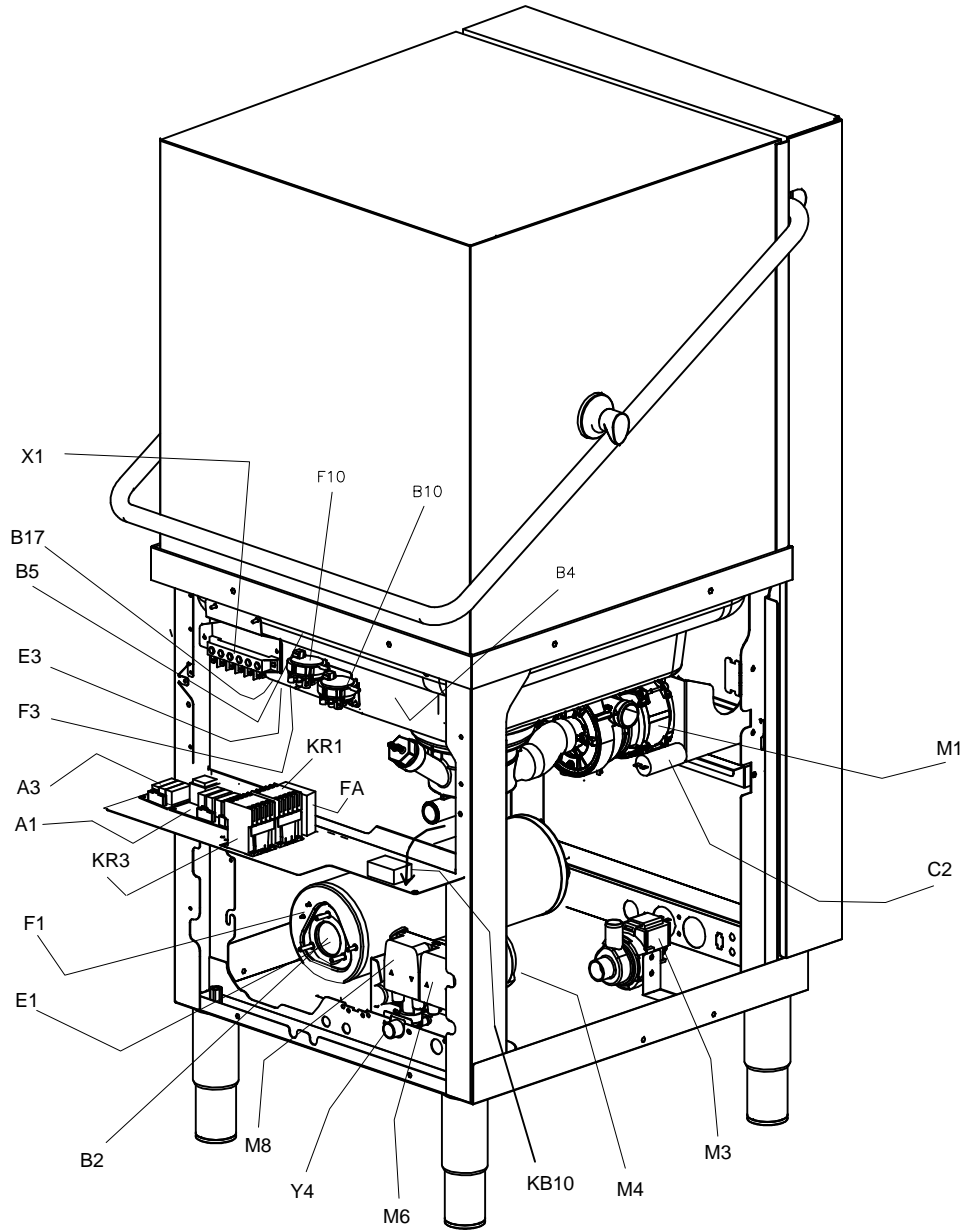

		denomination		Codice	
re-examined	date	WIRING DIAGRAM		81726	
	23/02/12				
inspected by	date	Dishwashers		n°/file	nod
validated by	date	total blat	N° blat	Next blat	
		3	2	-3	
				81797	--

DESCRIZIONE	SOSTITUISCE	DATA

